

# AZEK<sup>®</sup> EXTERIORS

ENGINEERED TO  
LAST BEAUTIFULLY

TRIM | MOULDING | SIDING | FASTENING



# WE ARE AZEK EXTERIORS

INSPIRING YOUR BEST WORK.  
PLEASING HOMEOWNERS NOW AND FOR YEARS TO COME.



## THE #1 BRAND FOR PREMIUM POLYMER TRIM & MOULDING

We're committed to innovation so you can deliver the best-in-class designs your projects deserve.

With over 20 years in the business, industry-leading warranties, and unparalleled building materials technology, AZEK Exteriors has emerged as the marketplace leader in premium products. We are proud to have been chosen by you time and again, earning industry awards for quality and builder preference. Still, we are committed to pushing our innovation even further. We research, test, and design premium exteriors solutions for improved installation and longer-lasting performance.

Because your projects—and your discerning clients—deserve it.

### THE AZEK DIFFERENCE

Durability	04
PaintPro®	06
Working with AZEK	08
Recycling	10

### SIDING

Shingle Siding	14
Bevel	16
Board and Batten	18
Cladding	22

### AZEK TRIM

Overview	32
Trim and Sheet	34
Cornerboards	37
Skirt Boards	38
J-Series Trim	40
Soffit System	43
Column Wraps and Kits	44
Beadboard and Shiplap	46

### MOULDING

Crown	49
Sill	50
Casing	51

### WINDOW SURROUNDS

Six Classic Profiles	52
----------------------	----

### FASTENING

Cortex®	56
Adhesives	57

## WHY WOOD YOU EVER?

We wouldn't. Unlike our polymer products, wood can offer no reliable protection against the elements. With wood trim or siding, you should expect water damage from mold and rot, costly painting, and regular maintenance.



## INDUSTRY-LEADING WARRANTIES

We back the performance of our trim, moulding, and siding with a Lifetime Limited Warranty that covers rotting, delaminating, splintering, and swelling from excessive moisture.



### CLASS-A-RATED FLAME SPREAD INDEX

AZEK Trim and Siding with PaintPro® Technology maintains a Class A Flame Spread Rating. It's an excellent choice if you are building in wildfire country.



Moisture Resistant



Rot Resistant



Insect Resistant



Weather Resistant



Durable, Less Long-Term Maintenance



Lightweight

## DESIGNED FOR EASY INSTALLATION ENGINEERED TO ENDURE

Our premium products are made from engineered polymer using advanced materials science and crafted for installation ease. With moisture resistance and durability far superior to traditional wood and other non-wood alternatives, AZEK® ensures your build stays as beautiful on day 1,000 as on day 1.

### MOISTURE RESISTANT

AZEK boards are 100% protected, inside and out, from both water exposure and absorption.

### UNPRECEDENTED DURABILITY

Our flexible and durable engineered polymer prevents jobsite breakage and delivers long-lasting protection for homeowners.

### ROT RESISTANT

Say goodbye to splitting, splintering, and rotting caused by constant exposure to the elements.

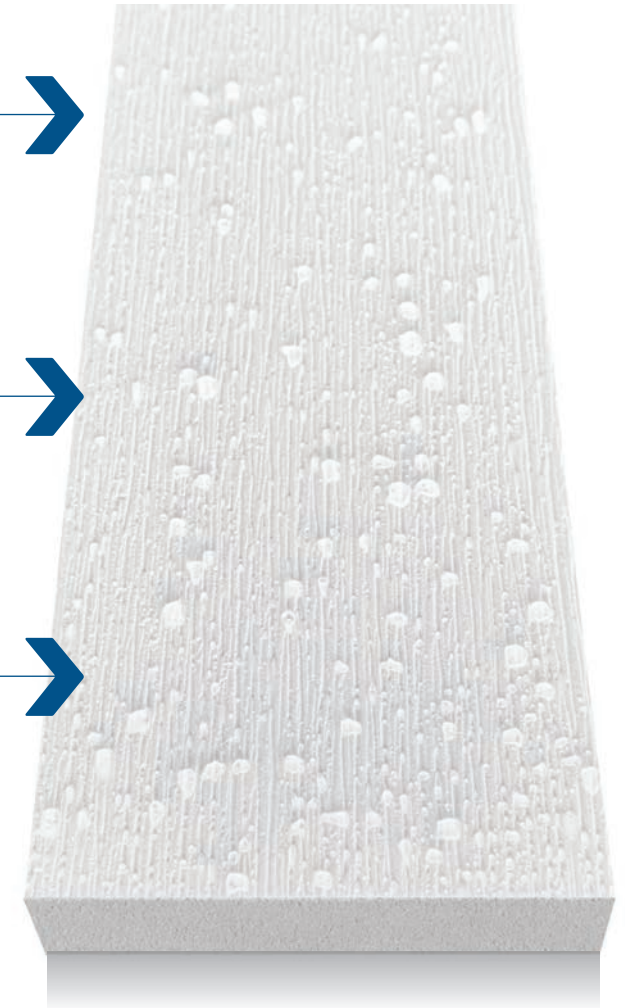

### RATE OF MOISTURE ABSORPTION\*

Even when painted, wood and other porous materials naturally absorb water. This leads to rot, mold growth, and material expansion. As trim or siding expands, the resulting movement can lead to unsightly damage and leave extended gaps in the exterior wrap, making other parts of the home susceptible to water damage.



100 DAYS

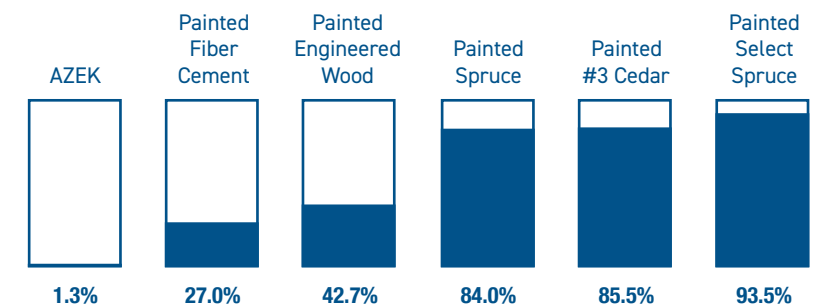

\* Results were based on internal testing performed by AZEK where materials were exposed to water and weighed to determine moisture absorption.

# PAINTPRO® TECHNOLOGY

## Engineered to be the best substrate for paint

AZEK Trim and Siding with PaintPro Technology offers a superior substrate for painting. Engineered for a superior bond with paint and enhanced for improved paint coverage without the need for any special prep, PaintPro Technology ensures longer-lasting curb appeal. Say hello to the revolutionary power of PaintPro Technology for exterior trim and siding and say goodbye to frequent maintenance and expensive repainting.

### AZEK TRIM AND SIDING PAINT TYPE GUIDELINES

COLOR RANGE	KEY COLOR SELECTION CRITERIA	PAINT TYPE
Lighter paint colors only	Must have a light reflective value (LRV) above 55	Exterior 100% acrylic latex
Light, medium, and some darker colors	Only use colors that are from a paint manufacturer's approved color list for vinyl siding. No custom colors.	Exterior 100% acrylic latex made for vinyl siding
Dark colors & custom colors	Available via special order only. Visit our custom colors and special-order paint page. <b>Never custom color match in local paint stores.</b>	Exterior 100% acrylic latex with solar reflective pigments

**REMEMBER:** Always make sure your paint is 100% water-based (acrylic) and suitable for exterior application.

SCAN TO SEE  
PAINT AND COLOR  
RECOMMENDATIONS



### READY TO PAINT

No sanding. No priming.  
Faster dry times.

### SUPERIOR ADHESION

Paint creates a strong bond with PaintPro Technology to reduce chipping, cracking, and other paint defects over time.

### LOW MAINTENANCE

Enjoy a painted finish that endures beautifully without the need for constant repainting.



## AVAILABLE PRODUCTS

### TRIM AND SHEET

Available in over 20 profiles, including One-Piece Skirt and Corner Boards. Add color to any job. Reversible trim in smooth and woodgrain finish. See page 34.

### SHINGLE SIDING

Available in three profiles, including staggered and straight patterns. Shingle siding offers the look of cedar with a vertical woodgrain emboss. See page 15.

### BOARD AND BATTEN SIDING

Available in 8', 10', and 12' sheets, and batten strips in 1 1/2" and 2 1/2" widths, for options to customize your design. See page 19.



# AZEK® PRODUCTS ARE DESIGNED TO PROVIDE INSTALLATION SOLUTIONS

AZEK offers more trim sizes and solution-based moulding profiles than any other brand on the market. Our engineered polymer products serve as the exteriors solution you need—and your project deserves.



## INTEGRATED DRIP EDGE

Designed for water management around doors and windows, it's also ideal for band board installations. See page 39.

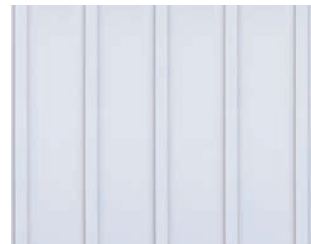

## BOARD AND BATTEN

AZEK Sheet and Trim with PaintPro Technology are a perfect solution for Board and Batten Siding. See page 19.



AZEK  
SIDING



## STRAIGHT AND STAGGERED SHINGLE SIDING

AZEK Shingle Siding available in three sizes, all with PaintPro Technology. See page 20.



## FLANGE SLOTTED TRIM, RABBETED TRIM, AND J-SERIES J-CASING

Trim boards are designed to reduce installation time and create beautiful window and door surrounds. See page 36.

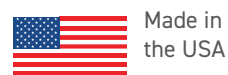

## UNIVERSAL SKIRT BOARD OR ONE-PIECE SKIRT BOARD

The perfect transition between siding and grade with no starter strips needed. See page 39.



## J-SERIES QUICK CORNER™ OUTSIDE CORNER

One-piece corner boards install quickly with no caulk required and no unsightly edges. See page 42.



## J-SERIES QUICK CORNER INSIDE CORNER

Inside Corner installs with hidden fasteners to eliminate the need for excessive face nailing and touch-ups. See page 42.



## THREE-PLUS-ONE COLUMN WRAP

Easy-to-install three-plus-one column wrap saves time and installation costs. See page 44.



## JOIN US IN CREATING A MORE SUSTAINABLE FUTURE

As the innovative manufacturer of beautiful, low-maintenance, environmentally sustainable exterior building products, AZEK® is deeply committed to making a lasting impact on the world by accelerating the use of recycled materials. We pursue initiatives that positively impact our products, our industry, and our planet. Leveraging our R&D strengths, we introduce products that increasingly utilize recycled materials. We're working to meet our own ambitious targets, like using 1 billion pounds of recycled waste and scrap material annually by the end of 2026 in the manufacturing of our products.

### HELP US TO REDUCE LANDFILL WASTE AND RECYCLE MORE BUILDING MATERIAL SCRAP

DIVERTED OVER  
**500 MILLION** POUNDS  
of scrap and waste from landfills through our recycling programs in 2022



ASPIRING TO USE  
**ONE BILLION** POUNDS  
of recycled material annually by the end of 2026



#### GOODS THAT DO GOOD

We are proud to offer high-quality products across our portfolio that are made from up to approximately 90% post-consumer and post-industrial recycled materials.



#### WE GET SCRAPPY

AZEK's FULL-CIRCLE PVC Recycling Program reduces landfill waste at the jobsite, helping installers and homeowners choose more sustainable homes.



### PVC SCRAP RECYCLE BIN PROGRAM

As a part of the AZEK FULL-CIRCLE Recycling™ Program, we are partnering with our network of dealers and distributors to offer recycle bins to collect PVC trim, siding, and cladding scrap. Contractors can request bins from participating dealers to collect jobsite scraps, reduce associated landfill fees, and make an environmental impact in their market.

### GET INVOLVED TODAY! LEARN MORE ABOUT THE AZEK FULL-CIRCLE PVC RECYCLING SCRAP COLLECTION PROGRAM.

- Find recycle bin locations in your area
- Get set up with bins at your dealer location
- Inquire about bins at an actual jobsite



LEARN MORE

The AZEK Company is a Gold member of the US Green Building Council and is pleased to support project teams working to attain LEED certification. AZEK's Chicago headquarters are LEED certified. For details about how AZEK supports LEED certification, review our LEED playbook below.

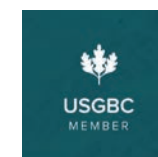

AZEK  
LEED  
PLAYBOOK





## AZEK® PREMIUM SIDING WITH PAINTPRO TECHNOLOGY

Once installed, AZEK Siding options achieve best-in-class aesthetics with the performance and low-maintenance benefits of rot-proof PVC building materials. Leveraging our innovative PaintPro Technology, AZEK Shingle and Board & Batten offer rapid paint dry times, superior paint adhesion, and a painted finish that lasts without needing frequent maintenance. Delivering enduring beauty with superior durability has never been so effortless.



Moisture Resistant



Rot Resistant



Insect Resistant



Weather Resistant



Durable, Less Long-Term Maintenance



Lightweight



Engineered for Paint



## AZEK® SHINGLE SIDING WITH PAINTPRO® TECHNOLOGY

AZEK Shingle Siding uses state-of-the-art proprietary engineered polymers for superior endurance, durability, and rot resistance to deliver an authentic and timeless wood look. Enhanced with PaintPro Technology, AZEK® Shingle Siding delivers a long-lasting painted finish without the frequent maintenance. Get the timeless look of cedar siding with enhanced endurance and moisture resistance, no matter the climate. Available in three profiles. **See page 20 for details.**



### STRAIGHT SHINGLE 7" AND 5" REVEAL

Consistency with a dash of variety. Uniform horizontal lines with varied width tabs and keyways for the most natural-looking shingle to beautifully complement modern or classic exterior architecture.

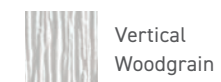

Vertical  
Woodgrain

### STAGGERED SHINGLE 6" REVEAL

Patterns with individual character, dimension, and diversity. Each random-edge panel enhances the overall pattern for an amazing exterior picture. Beautiful variety in both vertical and horizontal lines.

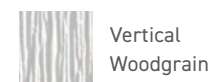

Vertical  
Woodgrain





## AZEK BEVEL SIDING

### AUTHENTIC SANDED CEDAR APPEARANCE

AZEK Bevel looks so much like real cedar siding, it can repair and replace rotted cedar boards seamlessly. When it wraps an entire house, rot is a thing of the past. Installs with face nailing and without knots or finger-joints. Ready to paint without priming, AZEK Bevel creates a traditional look with the freedom of low, low maintenance. **See page 21 for details.**

Limited availability. Contact your sales representative.



Smooth,  
Brushed Finish



## BOARD & BATTEN SIDING MORE DESIGN OPTIONS

Traditionally, board and batten siding starts with wide vertical planks (boards), which are then joined together by thin vertical strips (battens) to cover the seams. Using AZEK Sheet as the board and AZEK narrow trim as the batten, design options in batten spacing are no longer limited to a specific size. AZEK Sheet and Trim used in board and batten is available in Classic White or with PaintPro Technology.



### TRADITIONAL NARROW SPACING

The spacing of board and batten used to be determined by the width of the boards. The boards most common width was 8", which led to the traditional narrow spacing. Narrow batten placement at 8" or 12" works well on smaller, more compact exterior spaces.



### ACCENT AND WIDE-WIDTH SPACING

With the popularity of the modern farmhouse design, batten spacing of 12" to 16" may be desired to enhance the modern approach and create a less cluttered look, especially on larger spans of siding.



# AZEK SHINGLE

SHINGLE SIDING	
7" Reveal Straight-Edge Shingle Panel	48" x 16" x 1/4"
6" Reveal Staggered-Edge Shingle Panel	48" x 15" x 1/4"
5" Reveal Straight-Edge Shingle Panel	48" x 12" x 1/4"

## CLASS-A-RATED FLAME SPREAD INDEX

AZEK® Shingle Siding not only boasts gorgeous aesthetics to improve the value of your home, but a Class A Flame Spread Rating to protect that value.



### 7" REVEAL STRAIGHT-EDGE SHINGLE PANEL

(43 panels per square)

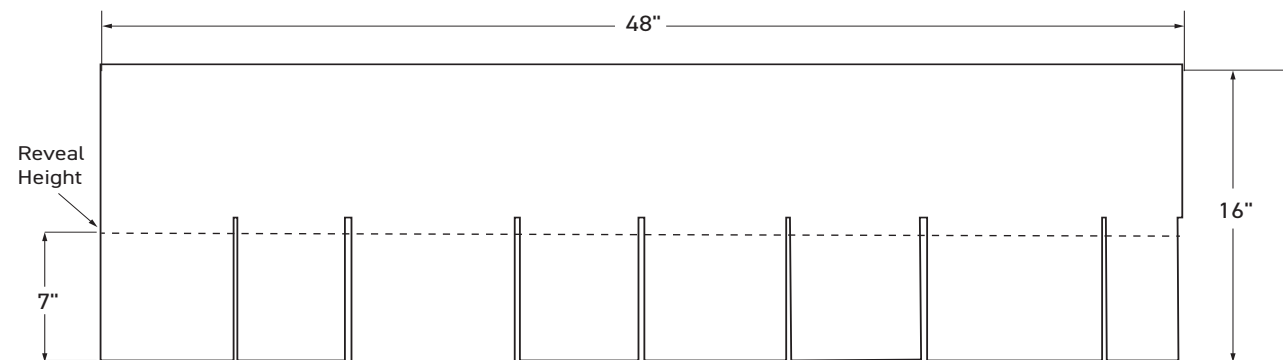

### 6" REVEAL STAGGERED-EDGE SHINGLE PANEL

(50 panels per square)

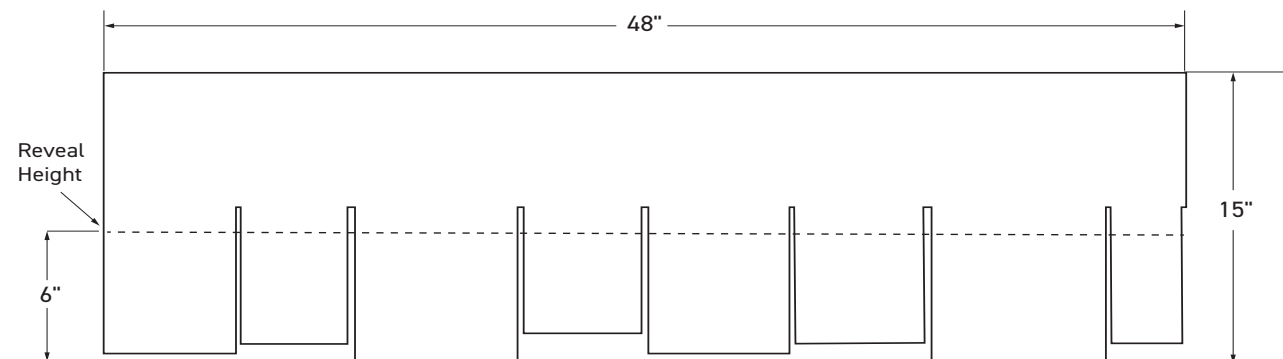

### 5" REVEAL STRAIGHT-EDGE SHINGLE PANEL

(60 panels per square)

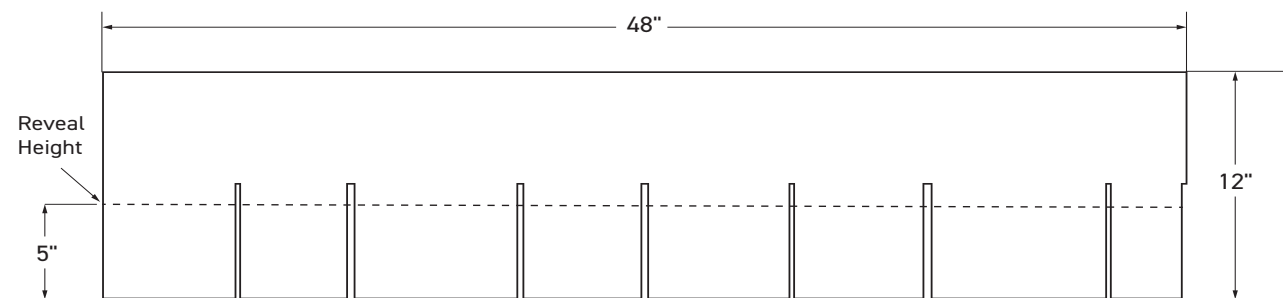

# BOARD AND BATTEN

## PAINTPRO TECHNOLOGY AZEK BOARD AND BATTEN

SHEET OPTIONS	
1/2" x 48" x 8'	Reversible Texture (Woodgrain/Smooth)
1/2" x 48" x 10'	Reversible Texture (Woodgrain/Smooth)
1/2" x 48" x 12'	Reversible Texture (Woodgrain/Smooth)
BATTEN OPTIONS	
3/4" x 1.5" x 16'	Reversible Texture (Woodgrain/Smooth)
3/4" x 2.5" x 16'	Reversible Texture (Woodgrain/Smooth)

## CLASS-A-RATED FLAME SPREAD INDEX

AZEK Board and Batten brings a beautiful look, both traditional and contemporary, to your home, as a Class A Flame Spread Rating inspires confidence.



### AZEK SHEET (ALL REVERSIBLE)

1/2" x 4' x 8' (Classic White or PaintPro)	1/2" x 4' x 10' (Classic White or PaintPro)
1/2" x 4' x 12' (Classic White or PaintPro)	

## CLASSIC WHITE AZEK BOARD AND BATTEN

SHEET OPTIONS	
1/2" x 48" x 8'	Reversible Texture (Woodgrain/Smooth)
1/2" x 48" x 10'	Reversible Texture (Woodgrain/Smooth)
1/2" x 48" x 12'	Smooth
BATTEN OPTIONS	
3/4" x 1.5" x 18'	Reversible Texture (Woodgrain/Smooth)
3/4" x 2.5" x 18'	Smooth

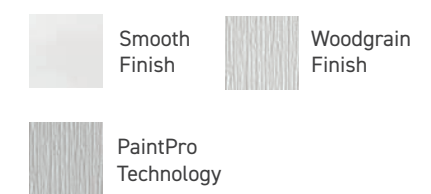

### AZEK TRIM

3/4" x 1 1/2" x 16' PaintPro (Reversible)
3/4" x 2 1/2" x 16' PaintPro (Reversible)
3/4" x 1 1/2" x 18' Classic White (Smooth Only)
3/4" x 2 1/2" x 18' Classic White (Reversible)

# AZEK BEVEL

BEVEL SIDING		
Dimensions	Reveal	Length
5.25" x 7/16"	4"	12'

## CLASS-A-RATED FLAME SPREAD INDEX

AZEK Bevel Siding not only boasts gorgeous aesthetics to improve the value of your home, but a Class A Flame Spread Rating to protect that value.



### 4" REVEAL BEVEL BOARD

(25 boards per square)

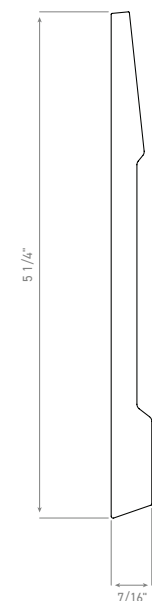

SHOWN: TIMBERTECH®  
VINTAGE COLLECTION®  
IN COASTLINE®

**TimberTech**®

PVC CLADDING

BY AZEK®



## TIMBERTECH® CLADDING

AZEK Exteriors joins with the power of TimberTech to offer Advanced PVC Cladding that delivers the full aesthetic experience of wood without the laborious, costly, and constant upkeep required with traditional lumber. TimberTech's one-of-a-kind polymer boards use technology and artistry to achieve a hyper-realistic wood look that lasts—that's why we back them with industry-leading warranties for both commercial and residential applications. Enjoy design flexibility with a variety of color choices, finishes, board profiles, and board widths.



Moisture  
Resistant



Rot  
Resistant



Insect  
Resistant



Weather  
Resistant



Durable, Less Long-  
Term Maintenance



UV Fade  
Resistance



Lightweight

# LET YOUR DESIGNS SOAR

With an unmatched portfolio of diverse colors, woodgrain patterns, and board widths, the design potential with TimberTech® Cladding is nearly limitless. With moisture- and fade-resistant Advanced PVC technology, TimberTech Cladding boards protect the integrity of your exterior design for years to come. Build on the rich hues and textures of TimberTech Cladding to highlight an entryway, add design detail to a porch, or as one element among mixed building materials for a clean, dimensional finish.

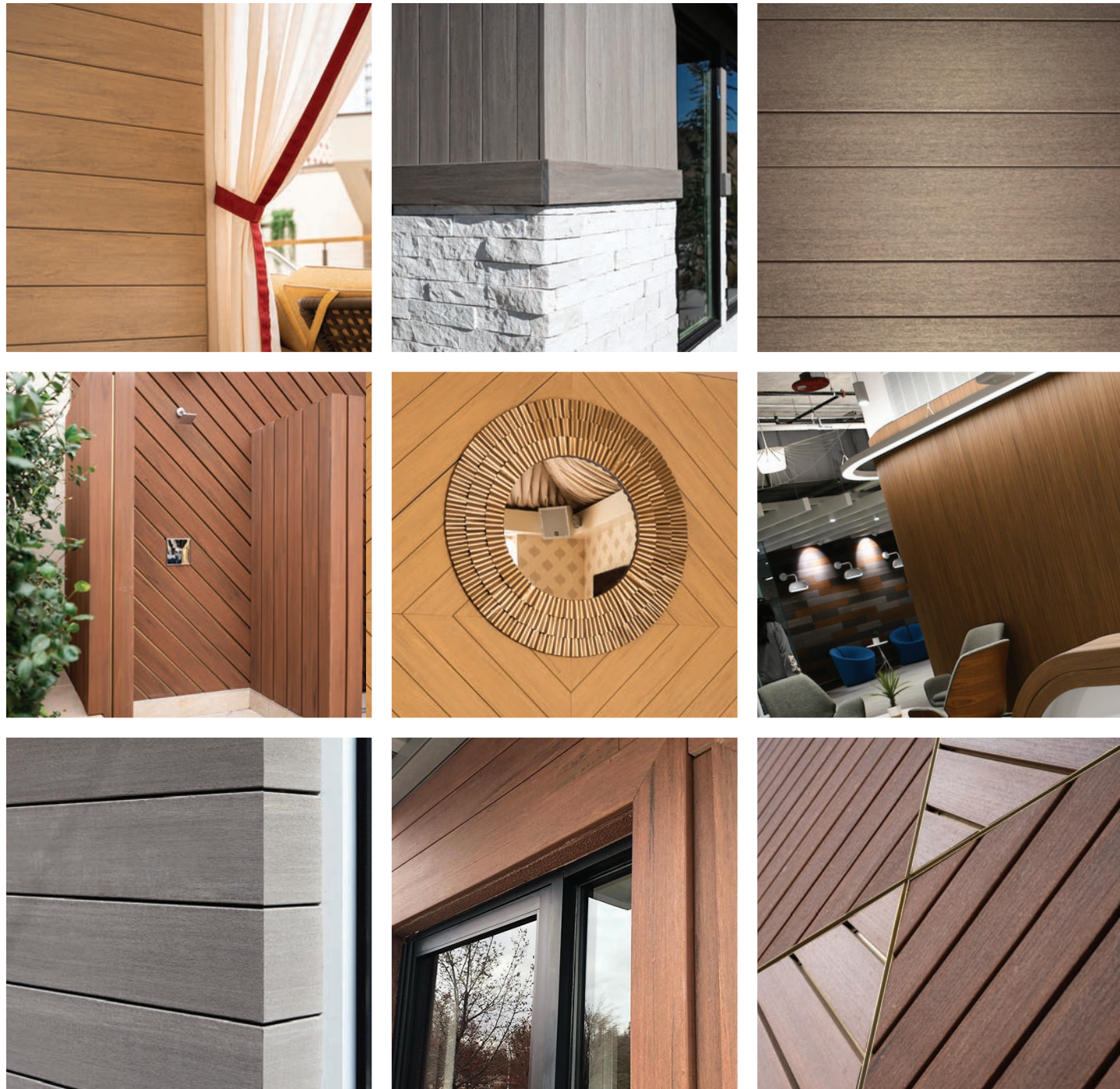

## APPROVED FOR RESIDENTIAL AND COMMERCIAL

TimberTech® Cladding is the only PVC cladding brand in the industry that offers tongue-and-groove (closed-joint) cladding and square-shoulder (open-joint) cladding for commercial and residential use. TimberTech Cladding is approved for commercial, residential, and multifamily projects.

### RESIDENTIAL WARRANTIES

TimberTech Advanced PVC Cladding is backed by an industry-leading Lifetime Limited Warranty and 50-year Fade & Stain Limited Warranty.



### COMMERCIAL WARRANTIES

Bring the enduring beauty of TimberTech Cladding to your commercial builds with the confidence guaranteed from durable, low-maintenance materials and industry-best performance.



### CLASS-A-RATED FLAME SPREAD INDEX

The Vintage® Collection boasts gorgeous aesthetics to improve the value of your home and a Class A Flame Spread rating to protect that value.



GET FREE CLADDING SAMPLES



SHOWN: MAHOGANY  
5.5" SQUARE-SHOULDER BOARD

## VINTAGE COLLECTION®

The Vintage Collection offers the widest range of sophisticated color palettes and unique board widths in the industry, offering maximum design flexibility with options to fit any home's style. Defined by natural-looking colors that mimic the look of lpe, teak, and other hardwoods and a subtle wire-brushed, low-gloss finish, this elegant collection ensures a truly authentic wood look.



COASTLINE®



WEATHERED TEAK®

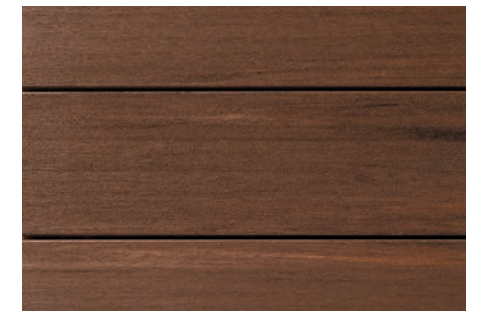

MAHOGANY

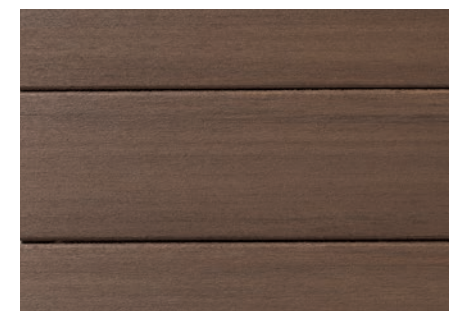

ENGLISH WALNUT®



DARK HICKORY



CYPRESS®

## LANDMARK COLLECTION

The Landmark Collection is designed to resemble popular hardwoods like white oak and walnut that have been crosscut for character-rich texture. Castle Gate offers the muted gray tones of weathered wood, but like all TimberTech® Cladding it is fade-resistant and needs no special maintenance. The crosscut grain with a matte finish delivers a soft yet textured look. Cascading colors define board-to-board color variation.



CASTLE GATE™



AMERICAN WALNUT®



FRENCH WHITE OAK®



BOARDWALK®



TONGUE-AND-GROOVE

SQUARE-SHOULDER

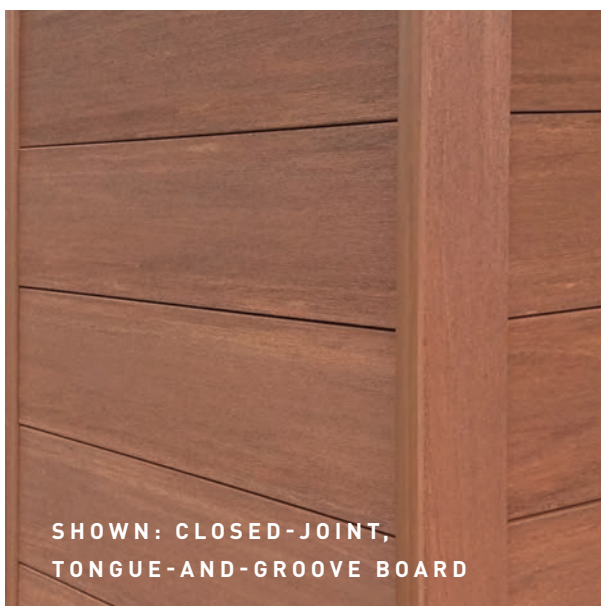

SHOWN: CLOSED-JOINT, TONGUE-AND-GROOVE BOARD

### CLOSED-JOINT CLADDING

Sometimes referred to as “closed-joint,” tongue-and-groove boards interlock together with ease, creating a solid barrier with a neat, smoothly finished look without gaps.

Tongue-and-groove board sizes:



SHOWN: OPEN-JOINT, SQUARE-SHOULDER BOARD

### OPEN-JOINT CLADDING

The open joints between the cladding elements create a strong, linear design pattern while also functionally providing ventilation for proper air circulation.

Square-shoulder board sizes:



TONGUE-AND-GROOVE	WIDE WIDTH 5 1/2"		STANDARD WIDTH 3 1/8"		
Standard Thickness 1"	12'	16'	10'	12'	16'
COASTLINE®	•	•		•	•
WEATHERED TEAK®	•	•		•	•
MAHOGANY	•	•		•	•
DARK HICKORY	•	•		•	•
ENGLISH WALNUT	•	•		•	•
CYPRESS	•	•		•	•

SQUARE-SHOULDER	NARROW WIDTH 3 1/2"	STANDARD WIDTH 5 1/2"	WIDE WIDTH 7 1/4"
VINTAGE Standard Thickness 1"	16'	16'	16'
COASTLINE®	•	•	•
WEATHERED TEAK®	•	•	•
MAHOGANY	•	•	•
DARK HICKORY	•	•	•
ENGLISH WALNUT	•	•	•
CYPRESS	•	•	•
LANDMARK Standard Thickness 1"	16'	16'	16'
FRENCH WHITE OAK		•	
CASTLE GATE		•	
AMERICAN WALNUT		•	
BOARDWALK®		•	



SEE FOR YOURSELF AND ORDER A FREE SAMPLE TODAY



The cladding applications depicted in this brochure are for display purposes only and not for the purpose of validating the suitability, warrantability, or safety of any particular installation or application of the product. Always consult AZEK's Installation Instructions to ensure proper installation.

Depending on environmental conditions, TimberTech cladding colors may appear to change over time as part of the natural weathering process and consistent with applicable Fade & Stain Warranties.



### CORTEX HIDDEN FASTENERS

The Cortex® hidden fastening system keeps the focus on the warm, authentic wood aesthetics that complement the entirety of the exterior design and not on the installation method.

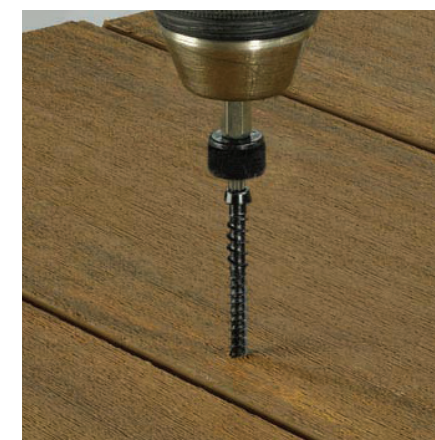



## EFFICIENT AND ENDURING TRIM & MOULDING

AZEK® offers more trim sizes and solution-based moulding profiles than any other brand on the market. By listening to the valued insight of contractors, architects, and homeowners, we solve exterior problems. Installation is simplified. Labor requirements are reduced. Design integrity is uncompromised. We are dedicated to delivering reliable, consistent products you can depend on to grow your business. AZEK PVC products serve as the exterior solution you need – and your project deserves.



Moisture  
Resistant



Rot  
Resistant



Insect  
Resistant



Weather  
Resistant



Durable, Less Long-  
Term Maintenance



Lightweight



PaintPro®  
Designed for Paint



# WHITE OR READY-TO-PAINT TRIM

## AZEK OFFERS STYLE-BASED SOLUTIONS

### Ready-to-Install Classic AZEK® Trim: Crisp, Bright White

The ultimate exterior matchmaker, AZEK Trim comes ready to install in brilliant white with two finish options (smooth and woodgrain) to complement and instantly elevate any surrounding. AZEK Classic Trim can be painted — but because paint is not required for a clean, finished look, installations go faster.



### Ready-to-Paint PaintPro Enhanced Trim: The Best Substrate for Paint

If your project requires painting trim, AZEK PVC Trim with PaintPro technology is the perfect choice. Ready to paint. No sanding. No priming. PaintPro Trim maintains the long-lasting, low-maintenance benefits of PVC trim while adding enhanced paintability. Paint bonds securely for lasting adhesion that resists splits, chips, and flakes.



\*PaintPro must be painted within 180 days of installation.  
Visit [AZEKexteriors.com/products/trim/trim-boards/paintpro-trim](https://www.azekexteriors.com/products/trim/trim-boards/paintpro-trim)

# AZEK TRIM OUTPERFORMS WOOD TRIM

AZEK Trim is made from 100% engineered polymer to provide a durable, long-lasting building material that is far more resistant to the elements than wood. No sealants are needed on surfaces or cut ends; every inch of our trim is equally protected against moisture. With superior uniformity, durability, workability, beauty, and much more, AZEK PVC Trim is the better choice for exteriors than wood.

	AZEK PVC TRIM	WOOD TRIM
<b>UNIFORMITY</b>		
Square edges	★	★
No knots, no waste; every inch usable	★	
<b>DURABILITY</b>		
Will not rot, split, splinter, delaminate, warp, or swell excessively from moisture	★	
Impervious to moisture and insect-resistant	★	
Suitable for ground and masonry contact	★	
Lifetime limited warranty	★	
Handles easily without breakage	★	★
<b>WORKABILITY</b>		
Use standard woodworking tools	★	★
Safely milled, shaped, and molded without special safety equipment	★	★
Can be heat-formed	★	
Fasten close to edge without predrilling	★	
<b>BEAUTY</b>		
Readily accepts paint*	★	★
Can be crafted for unique applications	★	★
<b>EXTRAS</b>		
Available in trim boards, sheets, cornerboards, beadboard, and mouldings	★	
Special labor-saving solution profiles available	★	

★ ALL PRODUCTS MEET CRITERIA  
 † SOME PRODUCTS MEET CRITERIA

\*PaintPro must be painted within 180 days of installation.  
 Visit [AZEKexteriors.com/products/trim/trim-boards/paintpro-trim](https://www.azekexteriors.com/products/trim/trim-boards/paintpro-trim).



GET FREE TRIM SAMPLES WITH  
PAINTPRO® TECHNOLOGY



### CLASSIC AZEK

Available in smooth or woodgrain finish

### PAINTPRO TECHNOLOGY

Reversible (one side smooth, one side woodgrain)



All AZEK Trim is long-lasting, moisture-resistant, and keeps its appearance with very little maintenance. Easily mill and router our trim, or heat form it before painting, for exquisite customized or curved applications. Classic AZEK Trim's brilliant white complements any exterior while AZEK Trim with PaintPro® was made to be painted.

## PROTECTIVE FILM KEEPS CLASSIC WHITE TRIM CLEAN

Classic AZEK Trim with protective film is available for smooth and woodgrain finishes. To ensure it looks as beautiful on your client's home as it does when it leaves our facilities, a protective film preserves AZEK Trim's crisp white semi-matte finish.

NOMINAL THICKNESS	NOMINAL WIDTH						
	4	5	6	8	10	12	16
5/4	SW	SW	SW	SW	SW	SW	SW
4/4	SW	SW	SW	SW	SW	SW	SW
5/8	SW	SW	SW	SW	SW	SW	SW

The film protects AZEK Trim through every production phase:

- Shipping
- Repackaging
- Installation
- Storage
- Handling

AZEK Trim with protective film should be kept dry prior to installation. Do not expose film to direct sunlight for extended periods. Protective film can be removed prior to, during, or immediately after installation.

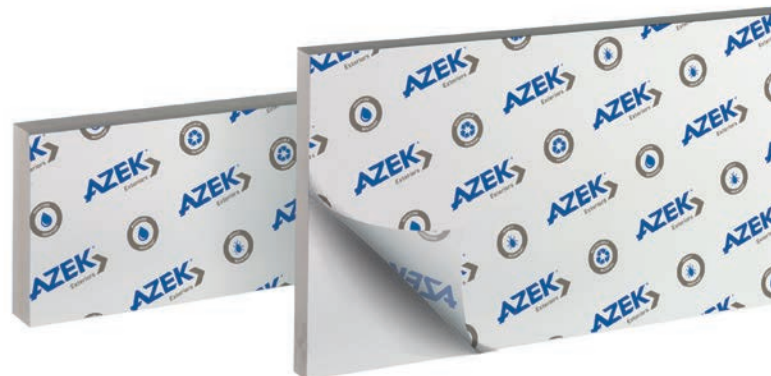

## AZEK® TRIM

### 8/4 X THICKNESS

NOMINAL	ACTUAL	18'
8/4 x 4	1 1/2" x 3 1/2"	S
8/4 x 6	1 1/2" x 5 1/2"	S
8/4 x 8	1 1/2" x 7 1/2"	S
8/4 x 10	1 1/2" x 9 1/2"	S
8/4 x 12	1 1/2" x 11 1/2"	S

### 6/4 X THICKNESS

NOMINAL	ACTUAL	20'
6/4 x 4	1 1/2" x 3 1/2"	W
6/4 x 6	1 1/2" x 5 1/2"	W
6/4 x 8	1 1/2" x 7 1/2"	W
6/4 x 10	1 1/2" x 9 1/2"	W
6/4 x 12	1 1/2" x 11 1/2"	W

### 5/4 X THICKNESS

NOMINAL	ACTUAL	12'	16'	18'	20'
5/4 x 4	1" x 3 1/2"	SW	P	SW	SW
5/4 x 5	1" x 4 1/2"	SW		SW	SW
5/4 x 6	1" x 5 1/2"	SW	P	SW	SW
5/4 x 8	1" x 7 1/2"	SW	P	SW	SW
5/4 x 10	1" x 9 1/2"	SW	P	SW	SW
5/4 x 12	1" x 11 1/2"	SW	P	SW	SW
5/4 x 16	1" x 15 1/2"	SW	P	SW	SW

### 4/4 X THICKNESS

NOMINAL	ACTUAL	12'	16'	18'
1 x 2	3/4" x 1 1/2"		P	SW
1 x 3	3/4" x 2 1/2"		P	
1 x 4	3/4" x 3 1/2"	SW	P	SW
1 x 5	3/4" x 4 1/2"	SW		SW
1 x 6	3/4" x 5 1/2"	SW	P	SW
1 x 8	3/4" x 7 1/2"	SW	P	SW
1 x 10	3/4" x 9 1/2"	SW	P	SW
1 x 12	3/4" x 11 1/2"	SW	P	SW
1 x 16	3/4" x 15 1/2"	SW	P	SW

### 5/8 X THICKNESS

ACTUAL	12'	18'
5/8" x 3 1/2"	SW	SW
5/8" x 5 1/2"	SW	SW
5/8" x 7 1/2"	SW	SW
5/8" x 9 1/2"	SW	SW
5/8" x 11 1/2"	SW	SW
5/8" x 15 1/2"	SW	SW



PaintPro Sheet Sheet ATM Sheet

## AZEK SHEET

Applications over 16" wide are easy with AZEK Sheet. Use Sheet for bay windows, dormers, and raised panels.

SHEET					
ACTUAL	8'	10'	12'	18'	20'
3/8" x 4'	SW	SW	S	S	
1/2" x 4'	SWP	SWP	SP	S	
5/8" x 4'	S	S	S	S	
3/4" x 4'	SWP	SWP	S	S	
1" x 4'	S	S	S	S	S

## AZEK-TO-MILL (ATM)

ATM's thick profile makes it an ideal material for fabrication. Its consistent density offers a superior product for milling operations.

AZEK-TO-MILL					
ACTUAL	8'	10'	12'	18'	20'
1 1/4" x 9 1/2"				S	
1 1/2" x 3 1/2"				S	
1 1/2" x 5 1/2"				S	
1 1/2" x 7 1/2"				S	
1 1/2" x 9 1/2"				S	
1 1/2" x 11 1/2"				S	
1 1/2" x 48" Sheet	S				
1 1/2" x 48" Sheet	S	S	S		S



Shown:  
Flange Slotted  
Window Trim and  
Cornerboard



Shown:  
Cornerboard



## FLANGE SLOTTED & RABBETED TRIM

Flange Slotted Window Trim and Rabbeted Trim are engineered to create beautiful, consistent, and long-lasting window surrounds by removing the installation challenges. Rabbeted trim is ideal for replacing existing trim. The cut flange easily covers existing siding. Ideal for new construction, the Flange Slotted and Rabbeted Trim has a 3/4" pocket, and, if using a vinyl window, the nailing fin will be hidden. The relief on the back of the board allows it to sit over the nailing flange without shimming.

### FLANGE SLOTTED TRIM

NOMINAL	ACTUAL	18'
5/4 x 4" Slotted	1" x 3 1/2"	SW
5/4 x 6" Slotted	1" x 5 1/2"	SW

### RABBETED TRIM (1" x 1" channel)

NOMINAL	ACTUAL	18'
5/4 x 4	1" x 3 1/2"	SWP
5/4 x 6	1" x 5 1/2"	SW
5/4 x 8	1" x 7 1/2"	SW

### FLANGE SLOTTED AND RABBETED TRIM

NOMINAL	ACTUAL	18'
5/4 x 4" Slotted & Rabbeted	1" x 3 1/2" with 1/2" Rabbeted Channel	SW
5/4 x 6" Slotted & Rabbeted	1" x 5 1/2" with 1/2" Rabbeted Channel	SW

### FLANGE SLOTTED TRIM

The flange slot helps trim sit flush over a window's nailing flange.



### RABBETED TRIM WITH SIDING POCKET

This 1" trim is perfect for end wall terminations.



### FLANGE SLOTTED RABBETED TRIM WITH WINDOW AND SIDING POCKET

The ultimate trim to build a neat, professional window surround.

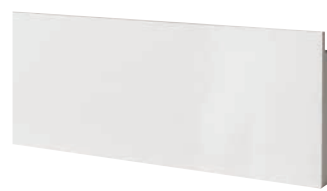

## CORNERBOARDS

AZEK Cornerboards offer faster installations and a seamless finish to complement any home exterior. Unlike two-piece cornerboards, which attract dirt in the seam, our one-piece cornerboards feature smooth outside edges to keep dirt away during installation.

### CORNERBOARD

NOMINAL	ACTUAL	10'	20'
5/4 x 4" x 4"	1" x 3 1/2" x 3 1/2"	SW	SWP
5/4 x 6" x 6"	1" x 5 1/2" x 5 1/2"	SW	SWP
5/4 x 8" x 8"*	1" x 7 1/4" x 7 1/4"		S

### RABBETED CORNERBOARD

NOMINAL	ACTUAL	10'	20'
5/4 x 4" x 4"	1" x 3 1/2" x 3 1/2"	SW	SW
5/4 x 6" x 6"	1" x 5 1/2" x 5 1/2"	SW	SW
5/4 x 8" x 8"*	1" x 7 1/4" x 7 1/4"		S

### INSIDE CORNERBOARD

NOMINAL	ACTUAL	10'	20'
2" x 2"	1 1/2" x 1 1/2"		P

### Cornerboard

Used with fiber cement and or wood siding. Caulk would be used when siding butts up against square trim face.



### Rabbeted Cornerboard

Most often used with vinyl siding, where siding tucks behind trim. NO caulk is needed.



\*5/4 x 8" x 8" only available in Traditional

## Seamless Cornerboards for Quick, Clean Installation

### The Problem

Multiple pieces requires more time and labor. Caulk is required to combine two trim boards. Other materials are not approved for ground and masonry contact.



### The Solution

Cornerboard means no seams, no caulk, and no paint required. Lengths up to 20' make installation faster.





Shown:  
One-Piece  
Skirt Board



Shown:  
Integrated Drip Edge



Shown:  
Universal Skirt Board

## Save on Installation Time & Cost Without Compromising Beauty

### The Problem

If using fiber cement, multiple pieces are needed and it is not approved for ground masonry contact.

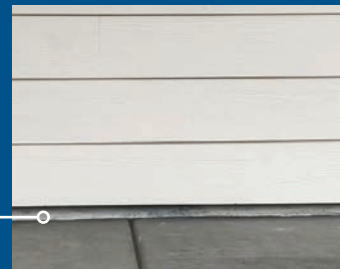

### The Solution

One-Piece Board is moisture-resistant, approved for ground contact.



## ONE-PIECE SKIRT BOARD

The perfect transition between siding and grade, the AZEK® One-Piece Skirt Board is designed to eliminate the need for a separate starter strip, skirt board, or flashing. In addition to its consolidated three-in-one function, the slanted top of the board helps drain water away from the structure and allows for easy application of paint.

ONE-PIECE SKIRT BOARD			
NOMINAL	ACTUAL	16'	18'
4/4 x 8	3/4" x 7 1/2"		SW
4/4 x 10	3/4" x 9 1/2"		SW
5/4 x 6	1" x 5 1/2"		SW
5/4 x 8	1" x 7 1/2"		SW
5/4 x 10	1" x 9 1/2"	P	SW



### One-Piece Skirt Board

No starter strip needed. One-piece design makes this profile ideal for painting.



## INTEGRATED DRIP EDGE

Designed to assist with water management efforts around doors and windows. Comes in two pieces with a reversible trim board; one side in smooth finish and the other in woodgrain finish. Routed to accept a drip edge for channeling water away from window and door surrounds. This profile design is also ideal for band board installations.

INTEGRATED DRIP EDGE		
NOMINAL	ACTUAL	18'
5/4 x 4	1" x 3 1/2"	W
5/4 x 6	1" x 5 1/2"	W
1 1/2" nailing flange length		
1/8" drip edge overhang		

### Integrated Drip Edge

Window and door surrounds assemble faster with the integrated nailing flange.



## UNIVERSAL SKIRT BOARD

A two-piece skirt board in reversible classic smooth or woodgrain finish designed to assist with water management and material transitions. Routed with a universal siding interface for quick and easy installation. Unlike other skirt boards, the AZEK Universal Skirt Board works well with fiber cement, vinyl, or wood siding.\* No starter strips needed.

UNIVERSAL SKIRT BOARD		
NOMINAL	ACTUAL	18'
5/4 x 6	1" x 5 1/2"	W
5/4 x 8	1" x 7 1/2"	W
5/4 x 10	1" x 9 1/2"	W
5/4 x 12	1" x 11 1/2"	W
1 1/2" nailing flange length		
1/2" drip edge overhang		

\*Universal Skirt Board works with many products; ensure compatibility before purchase.

### Universal Skirt Board

No starter strip needed, saves time on installation.



# J-CHANNEL TRIM SERIES

- One-piece corner and window trim installs quickly
- No caulk required and corner maintains its shape without seams opening
- Homeowners enjoy a more aesthetically pleasing look
- Approved for ground contact

**J-QUICK CORNERS**  
One-piece corners designed for fast installs with premium siding

**J-CASING**  
Single-piece trim designed to work with premium vinyl siding

No Caulk, No Paint, Fewer Steps—Faster Installation

**The Problem**

Wood and fiber cement corners require multiple boards and extra install time.



**The Solution**

One-piece inside and outside cornerboards with a J-Channel install quickly for a clean finish.

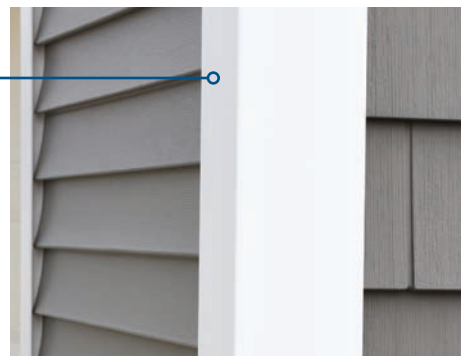

**The Problem**

Requires the purchase of both the trim board and J-Channel.



**The Solution**

AZEK® J-Casing has an integrated J-Channel and doesn't require paint for protection, reducing installation time and cost.





Shown:  
J-Series, J-Casing,  
and Quick Corner



Shown:  
Vented Soffit with  
Notched Fascia and  
Frieze

## J-CASING

AZEK® J-Casing offers the most beautiful and seamless transition between siding and trim. Engineered to reduce labor and save costs by eliminating the need for field-applied paint and caulk.

J-CASING				
DESCRIPTION	ACTUAL	12'	16'	18'
1 x 4 J-Casing	1 1/8" x 3 1/2"		S	S
1 x 6 J-Casing	1 1/8" x 5 1/2"	S		
BRICK MOULD J-CASING				
DESCRIPTION	ACTUAL	18'		
Brick Mould J-Casing	1 1/4" x 2"	S		



## J-CHANNEL QUICK CORNER™

Installed with hidden fasteners, completely eliminating the need for excessive face nailing and touch-up. Use with multiple types of sidings.

J-CHANNEL QUICK CORNER OUTSIDE CORNER		
DESCRIPTION	ACTUAL	20'
4 x 4 J-Quick Corner	1" x 3 1/2" x 3 1/2"	S
6 x 6 J-Quick Corner	1" x 5 1/2" x 5 1/2"	S
J-CHANNEL QUICK CORNER INSIDE CORNER		
DESCRIPTION	ACTUAL	20'
3 x 3 J-Quick Corner	3/8" x 2 1/2" x 2 1/2"	S

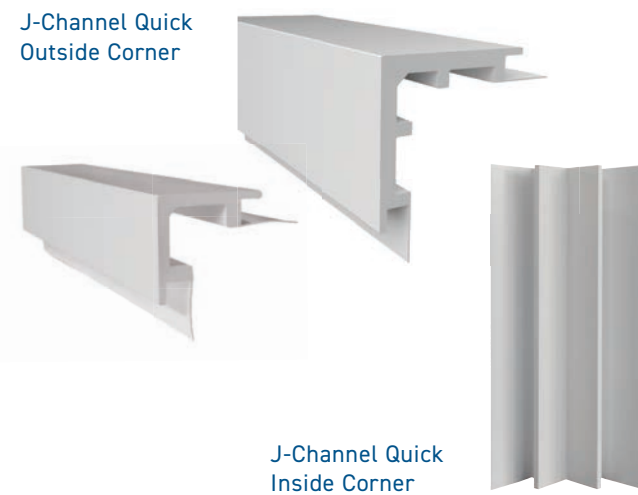

## SOFFIT, SOLID AND VENTED

Available in two profiles, solid and vented. Both provide climate-resistant material for smooth, beautiful finishing to match any home exterior. The vented soffit has 8" of venting and 4" of solid pattern that provides 10" of free air space per lineal foot to meet or exceed most building codes for ventilation. Vents are cut at an angle to prevent insects from nesting; no additional screening necessary.

SOFFITS		
ACTUAL	VENTED 18'	SOLID 18'
1/2" x 12"	S	S
1/2" x 16"	S	S



## FRIEZE & FASCIA

Use the frieze board and notched fascia for an efficient, easy-to-install soffit system. Both have a 1/2"-deep groove to smoothly join with soffits. The notched fascia requires no flashing or cover.

NOTCHED FASCIA		
NOMINAL	ACTUAL	18'
4/4 x 8"	3/4" x 7 1/4"	S
FRIEZE BOARD		
NOMINAL	ACTUAL	18'
5/4 x 6"	1" x 5 1/2"	S

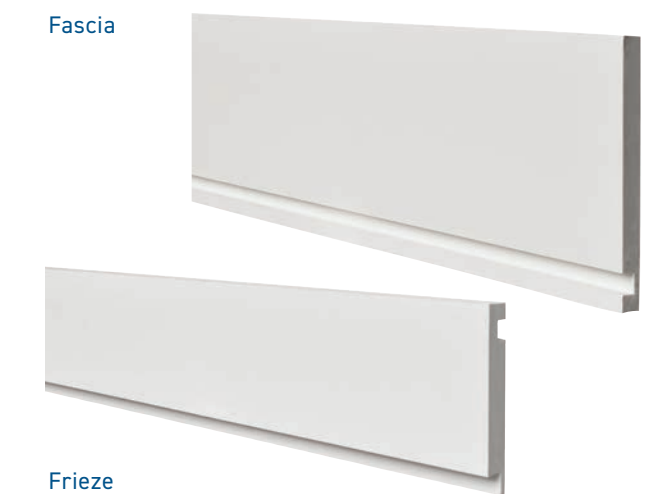



## AZEK® THREE-PLUS-ONE COLUMN WRAP

This easy-to-install Three-Plus-One Column Wrap profile saves time and installation costs. Three connected panels and a fourth “locking” panel fit easily and securely around a structural support with press-fit seams and clean corners.

THREE-PLUS-ONE COLUMN WRAP

NOMINAL	INSIDE DIMENSION	OUTSIDE DIMENSION	8' 6"	10'
4 x 4	3 3/4" x 3 3/4"	4 1/2" x 4 1/2"	S	S
6 x 6	5 1/2" x 5 1/2"	6 3/4" x 6 3/4"	S	S
8 x 8	7 1/2" x 7 1/2"	8 3/4" x 8 3/4"	S	S

Smooth Finish (S)



**Column Wrap**  
Installs quickly with three interlocking boards and a precut locking panel.

## TAPERED COLUMN

The four-piece AZEK Tapered Column combines a craftsman aesthetic with a column wrap's ease of installation. Four precut panels each feature a friction-fit miter lock joint to ensure a secure fit and the correct angle for each panel. Includes squaring corners and 3 1/2" decorative skirt pieces for the cap and base of each column to fasten and accessorize.

TAPERED COLUMN WITH BASE SKIRT

ACTUAL	5'	6'
12" base / 8" cap	S	S
16" base / 12" cap	S	S

Smooth Finish (S)



## AZEK® THREE-PLUS-ONE COLUMN WRAP ACCESSORIES

Embellish your Three-Plus-One Column Wraps with moulding kits and accent wraps. Accessory kits can be purchased to enhance the column and give you the decorative look you desire.

THREE-PLUS-ONE COLUMN WRAP ACCESSORIES

DESCRIPTION	4"	6"
TRIM KIT - BASE MLDG	S	S
TRIM KIT - BED MLDG	S	S
TRIM KIT - BED MLDG XL	S	S
TRIM KIT - CROWN MLDG	S	S
TRIM KIT - CROWN MLDG XL	S	S
ACCENT WRAP 10"	S	S

Smooth Finish (S)

**Column Wrap Accessories**  
Kits connect with precut dovetails to speed installation on decorative details.





Shown:  
Reversible  
Beadboard



Shown:  
Shiplap

## Plentiful Options for Ceilings and Walls

Beadboards and Beaded Sheets offer broad and beautiful coverage for ceilings under raised decks or above the porch. Tongue-and-groove profiles can be oriented on walls horizontally or vertically. Just like all AZEK® Trim and Moulding, every product for exterior ceilings and walls is made from moisture-resistant, low-maintenance PVC and designed to elegantly complement and elevate the entire exterior.

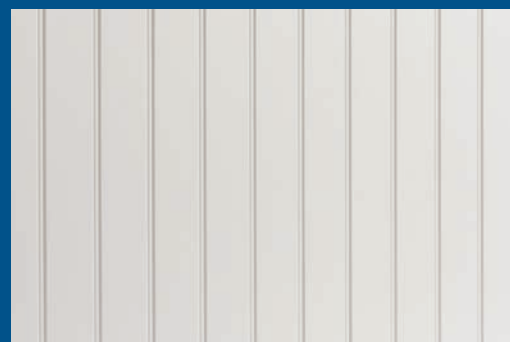

Beaded Sheet

## BEADBOARD E & CB

AZEK Beadboard (E & CB) is certified UL580 class 90 wind gust uplift-resistant, making it ideal for use in coastal areas. It is reversible and perfect for wainscoting, with an edge and center bead on one side and a v-groove on the other.

BEADBOARD	
ACTUAL	18'
½" x 3 ½"	<b>S</b>
¾" x 3 ½"	<b>S</b>
¾" x 5 ½"	<b>S</b>

BEADED SHEET	
ACTUAL	8'
½" x 4'	<b>S</b>



**Beadboard (E & CB)**  
Add character to any wall or ceiling with the classic and cozy look of beadboard.



## REVERSIBLE BEADBOARD

AZEK® Beadboard is reversible with an edge and center bead on one side and a V-groove on the other, perfect for wainscoting and porch ceilings.

BEADBOARD	
ACTUAL	18'
⅝" x 3 ½"	<b>S</b>
½" x 5 ½"	<b>S</b>

\*Features a nailing flange for easier installation.



**Reversible Beadboard**  
V-Groove provides wider planks and a more formal aesthetic compared to beadboard on the reverse side.



## SHIPLAP & NICKEL GAP

Bring the contemporary look of wider planks with either shiplap or nickel gap. Both deliver similar finished looks, but the tongue-and-groove nickel gap and reversible WP4 allow for hidden fasteners. Each profile type is suitable for horizontal and vertical orientation.

TONGUE-AND-GROOVE SHIPLAP	
ACTUAL	18'
¾" x 5 ½"	<b>S</b>
¾" x 7 ½"	<b>S</b>

TONGUE-AND-GROOVE NICKEL GAP/WP4 (REVERSIBLE)	
ACTUAL	18'
¾" x 5 ½"	<b>S</b>

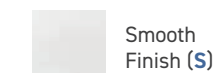

**Shiplap**  
Combine with overlapping "rabbeted" joints.

**Nickle Gap**  
Tongue-and-groove joints and reverse side offers V-groove aesthetic.





# AZEK® MOULDING

With over 30 different profiles to mix and match, you can customize any build with a distinctive look.



## THE MOST BEAUTIFUL, HIGH-PERFORMANCE MOULDING LINE AVAILABLE

With crisp, architectural details reminiscent of premium wood mouldings, high-performance AZEK® Moulding will last beautifully without the maintenance hassles associated with wood. Backed by AZEK's promise of high quality and lasting performance, AZEK Moulding will retain a like-new appearance despite the tests of time and weather. AZEK Moulding offers greater stability and predictability when fastening. Unlike traditional wood moulding, AZEK Moulding resists moisture and insect damage and will not rot or split.

# CROWN PROFILES

Crown moulding profiles are typically decorative mouldings designed for use along the intersection of a wall or ceiling. They may be combined with other mouldings to create a built-up profile.

<p><b>3" CROWN AZM-52</b> LENGTH: 16'</p>	<p><b>4" CROWN AZM-49</b> LENGTH: 16'</p>	<p><b>5" CROWN AZM-47</b> LENGTH: 16'</p>	<p><b>6" CROWN AZM-45</b> LENGTH: 16'</p>
<p><b>8" CROWN AZM-43</b> LENGTH: 16'</p>	<p><b>COVE MOULDING AZM-80</b> LENGTH: 16'</p>	<p><b>BED MOULDING AZM-75</b> LENGTH: 16'</p>	<p><b>3 1/2" BED MOULDING AZM-28</b> LENGTH: 16'</p>
<p><b>IMPERIAL RAKE CROWN AZM-6937</b> LENGTH: 16'</p>	<p><b>RAMS CROWN AZM-6934</b> LENGTH: 16'</p>	<p><b>SOLID CROWN AZM-7954</b> LENGTH: 16'</p>	<p><b>CROSSHEAD PEDIMENT AZM-6216</b> LENGTH: 18'</p>

# DETAIL & SILL/DRIP PROFILES

AZEK® Drip profiles can be used as a water table or brick ledge for separation and watershed against two different materials. AZEK Sill profiles shed water and offer architectural detail.



Denotes Water Management Drip Edge

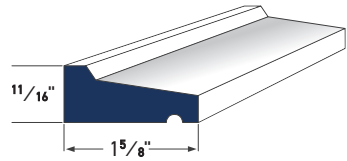

DRIP CAP AZM-197  
LENGTH: 16'

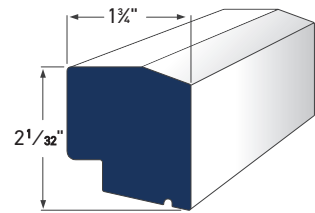

HISTORIC SILL AZM-6930  
LENGTH: 16'

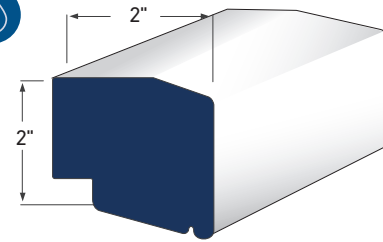

LARGE SILL NOSE AZM-7979  
LENGTH: 16'

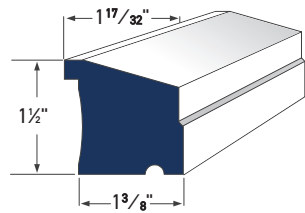

SUB SILL NOSE AZM-6933  
LENGTH: 16'

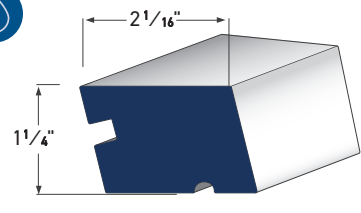

WINDOW SILL NOSE AZM-7974  
LENGTH: 12'

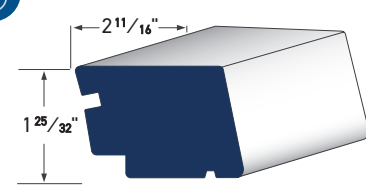

LARGE HISTORIC SILL AZM-7958  
LENGTH: 16'

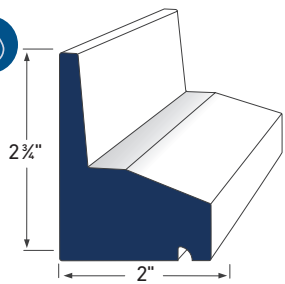

WATER TABLE AZM-6935  
LENGTH: 18'

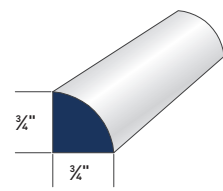

QUARTER ROUND AZM-105  
LENGTH: 16'

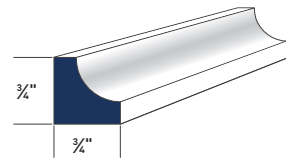

SCOTIA AZM-93  
LENGTH: 16'

# CASING PROFILES

Use AZEK® Casing Profiles as decorative moulding against a wall, door, or window to create surrounds. Elevate your framing with style and durability.

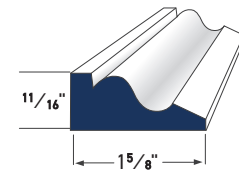

BAND MOULDING AZM-217  
LENGTH: 16'

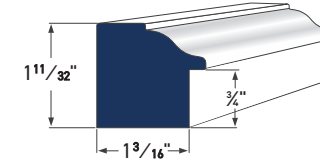

BACK BAND AZM-6931  
LENGTH: 16'

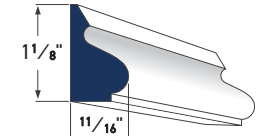

BASE CAP AZM-164  
LENGTH: 16'

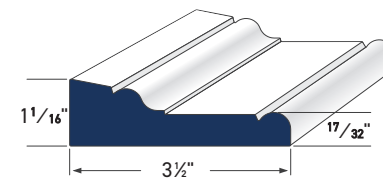

ADAMS CASING AZM-97  
LENGTH: 16'

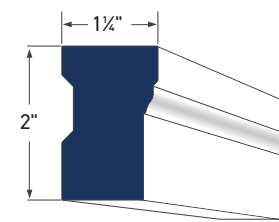

BRICK MOULD AZM-180  
LENGTHS: 16', 17' and 18\*\*

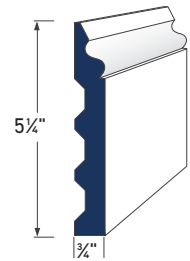

COLONIAL BASE CAP AZM-163  
LENGTH: 16'

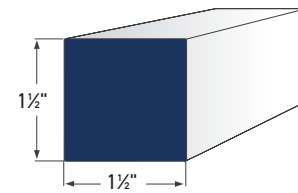

SQUARE PROFILE AZM-236  
LENGTH: 12'

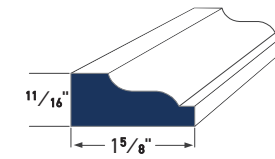

SHINGLE MOULD AZM-210  
LENGTH: 16'

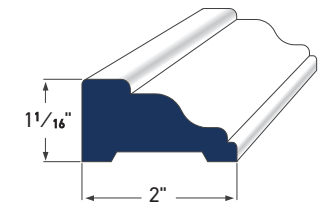

RAKE MOULDING AZM-287  
LENGTH: 16'

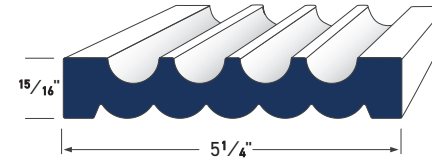

FLUTED/REEDED AZM-606  
LENGTH: 16'

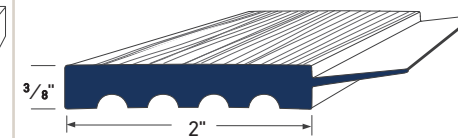

GARAGE DOOR THERMOSTOP  
AZM-6936 LENGTHS: 7', 9', and 16'

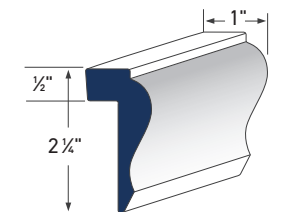

WAINSCOT CAP AZM-284  
LENGTH: 16'

\*\*18' Brick Mould (AZM-180) is available in full units only and cannot be ordered via the Pick & Pack program.



## CREATIVE FREEDOM MEETS INNOVATIVE EFFICIENCY WITH AZEK® SURROUND DESIGNS

Drawing inspiration from architectural archives and a diverse trim collection, AZEK® designers created a series of classic window and door surround designs to make style choices simple. These trim and moulding profiles are built up with varying shadow-line compositions and varying weights and widths, then matched with complementary sill profiles to give each surround its own character. Single-structure, pre-milled profiles reduce costly carpentry and assembly steps. AZEK Surround designs bring sophisticated styling and moisture management to your homes without breaking the budget.

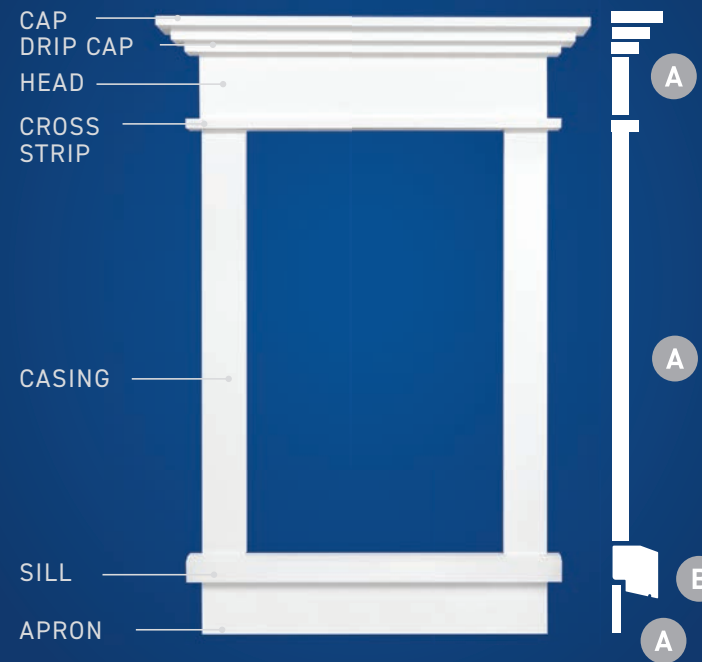

### STATESIDE

This surround grouping features horizontal stepping, casting distinct shadow lines. With its tall head and cap combination, the Stateside is best suited for large window or door arrangements, especially on historic home designs that call for dramatic horizontal definition. Match with the Historic Sill or Window Sill Nose.

TO CREATE THE STATESIDE SURROUND, USE THE PROFILES BELOW

- A**  
CAP: 6/4 x 2 1/2  
DRIP CAP: 5/4 x 4  
HEAD: 5/4 x 6  
CROSS STRIP: 4/4 x 2  
CASING: 5/4 x 4 or 6  
APRON: 5/4 x 4 or 6



- B**  
HISTORIC SILL  
AZM-6930  
LENGTH: 16'



- OR USE  
WINDOW SILL NOSE  
AZM-7974  
LENGTH: 12'



### HISTORIC RAMS HEAD

This assembly replicates a classic surround with subtle detail. An attractive one-piece crown mould and wide head makes installation a breeze. The Historic Rams Head surround delivers an intriguing yet simple aesthetic and is commonly used in Arts and Crafts-styled homes. The Historic Sill should be used with this surround.

TO CREATE THE HISTORIC RAMS HEAD SURROUND, USE THE PROFILES BELOW

- A**  
CROSSHEAD PEDIMENT  
AZM-6216  
LENGTH: 18'



- B**  
CASING: 5/4 x 4  
APRON: 5/4 x 4



- C**  
HISTORIC SILL  
AZM-6930  
LENGTH: 16'



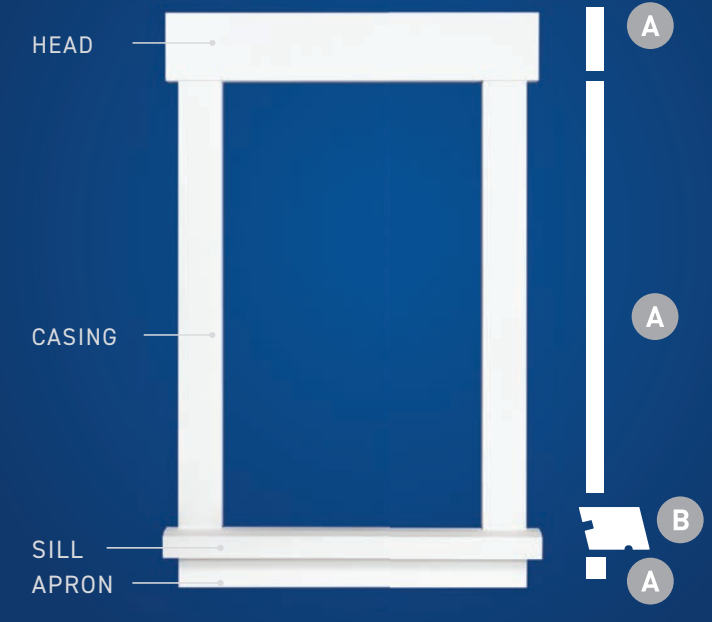
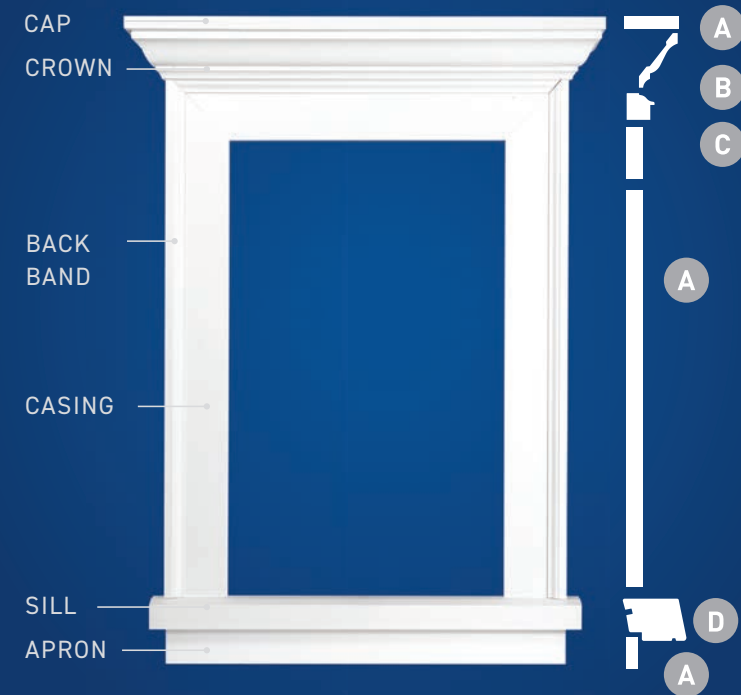
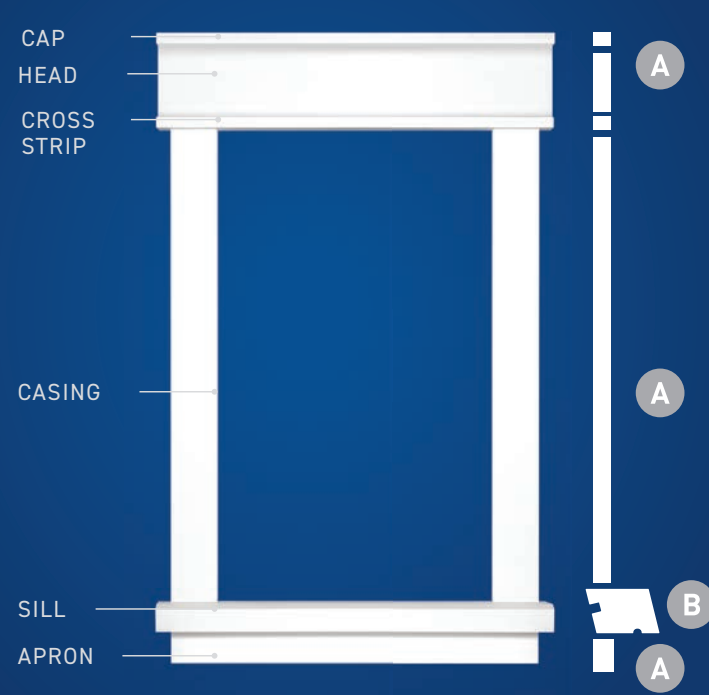

## DOUBLE-CROSS HEAD

For clean, versatile styling, the Double-Cross Head surround accentuates strong horizontal shadow lines above and below the smooth-head member. The effect complements other trim detailing around the home without appearing overly decorative. The Window Sill Nose assembly is recommended.

TO CREATE THE DOUBLE-CROSS HEAD SURROUND, USE THE PROFILES BELOW

**A**

CAP: 4/4 x 2  
HEAD: 5/4 x 6  
CROSS STRIP: 4/4 x 2  
CASING: 5/4 x 6  
APRON: 5/4 x 4 or 6



**B**

WINDOW SILL NOSE  
AZM-7974  
LENGTH: 12'



## CROWNED BANDIT

The Crowned Bandit surround is ideal when a stronger vertical presence or higher level of detail is desired versus a linear approach. It's typically used to complement other moulded elements found in cornices, frieze banding, and columns. Finish with the Large Historic Sill profile.

TO CREATE THE CROWNED BANDIT SURROUND, USE THE PROFILES BELOW

**A**

CAP: 4/4 x 4  
CASING: 4/4 x 6  
APRON: 5/4 x 4 or 6



**B**

4" CROWN  
AZM-49  
LENGTH: 16'



**C**

BACK BAND  
AZM-6931  
LENGTH: 16'



**D**

LARGE HISTORIC SILL  
AZM-7958  
LENGTH: 16'



## HISTORIC BACK BAND

Featuring an edge detail around the casing and head elements, the defined shadowing in the Historic Back Band adds depth and width to window and door treatments. Use either the Historic Sill or moulded apron assembly to enhance this combination.

TO CREATE THE HISTORIC BACK BAND SURROUND, USE THE PROFILES BELOW

**A**

BACK BAND  
AZM-6931  
LENGTH: 16'



**B**

HEAD: 4/4 x 6  
CASING: 4/4 x 6  
APRON: 4/4 x 6



**C**

LARGE HISTORIC SILL  
AZM-7958  
LENGTH: 16'



## CLEAN & SIMPLE

While compatible for a wide variety of traditional styles, the Clean and Simple surround is best suited for small- to medium-sized windows. This assembly is a cost-effective solution that creates smooth, understated framing. The Window Sill Nose or moulded apron assembly are recommended for this assembly.

TO CREATE THE CLEAN AND SIMPLE SURROUND, USE THE PROFILES BELOW

**A**

HEAD: 5/4 x 6  
CASING: 5/4 x 4  
APRON: 5/4 x 4



**B**

WINDOW SILL NOSE  
AZM-7974  
LENGTH: 12'





## CORTEX® FOR AZEK® TRIM

Save time and labor costs with Cortex for AZEK Trim. The only concealed fastening system that quickly and easily fastens AZEK Trim to your building project, Cortex comes with plugs on collated strips to make fastening faster.

- Fast and easy: eliminates the need to caulk, sand, and paint each nail hole
- Plugs made out of same AZEK trim material, which keeps trim smooth and uniform
- Can be painted (available in Classic AZEK Trim and PaintPro Trim)
- Guaranteed corrosion resistance for life of the project; ACQ approved
- The felt tip on the unique bit prevents surface marring while driving fasteners securely below the trim surface
- Available in smooth and woodgrain

### Better Fastener, Better Aesthetics



Make installation faster and easier with collated strips of Cortex plugs.



When using PaintPro Trim, choose PaintPro Cortex plugs and paint to match trim color.



Drive fastener at 90° angle to preset level below trim surface.



Place plug with trim surface side-up into hole. Gently tap plug until flush with the trim.



## ADHESIVES & TOOLS

Use adhesives, sealants, and accessories engineered specifically to bond with PVC products. The AZEK® solvent-free structural adhesive system is designed for fast, easy installation and enduring strength.

### Right Product, Right Application

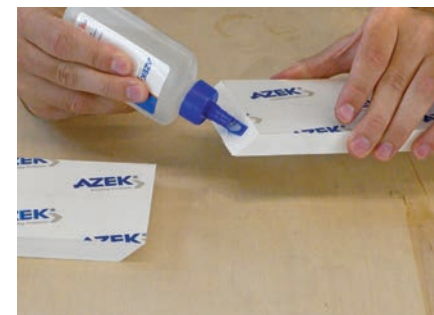

Use AZEK Cellular PVC Cement for securing joints and other trim connections requiring tight compression.



Use AZEK Fast Cure and Slow Cure to fill gaps and other trim connections that do not require tight compression. Use a putty knife to distribute and sand when dry for a smooth finish.



Apply Fast Cure or Slow Cure on trim with rough edges, then sand for a smooth finish.



Use AZEK Nail Eraser to smooth surfaces marked by nails with small surface heads.

# ADHESIVES

## CELLULAR PVC CEMENT

Clear, contact-style adhesive bonds with PVC in a fast-working time. Ideal for securing joints. Creates a powerful and reliable material bond with no sanding or scraping required.

Squeeze Bottle  
4 oz: AADB004OZ, 8 oz: AADB008OZ

Container with Applicator  
4 oz: AAD004OZ, 8 oz: AAD008OZ,  
16 oz: AAD016OZ, 32 oz: AAD032OZ,  
128 oz: AAD128OZ, 640 oz: AAD640OZ

- 24-hour curing time
- Clamp 24–48 hours for best results
- Water-soluble for easy cleanup when surfaces are still wet
- Convenient applicator built into lid
- Use AZEK Adhesive to connect trim when a tight compression is required, such as connecting trim end-to-end (scarf joints) and at corners (miter joints)



## FILL & FLEX

Use for expansion and contraction joints on PVC trim boards. Seals gaps around windows and doors. Slow curing, one-part urethane-based sealant with high level of flexibility and elongation to absorb expansion and contraction from heat or cold.

AAD300MLFF

- Premium-grade TiO<sub>2</sub> pigments
- Resists long-term yellowing
- Allows ample work time
- 300 ml



## FAST CURE 220 ML

AAD220MLFCS

## FAST CURE 50 ML

AAD50MLFCS

- White, two-part acrylic-based adhesive ideal for bonding AZEK to AZEK products; also bonds PVC to wood, metal, brick, vinyl, glass, and other PVC
- Work time 4–7 minutes at 70°F after mixing with Qwik-Mixer; fully cures in 24 hours
- Fills nail holes and gaps up to 1/8"
- Requires Qwik-Mixer for easy mixing and dispensing



## SLOW CURE 220 ML

AAD220MLSCS

## SLOW CURE 50 ML

AAD50MLSCS

- White, two-part acrylic-based adhesive ideal for bonding AZEK® to AZEK products; also bonds PVC to wood, metal, brick, vinyl, glass, and other PVC
- Work time 15–25 minutes at 70°F after mixing with Qwik-Mixer; fully cures in 24 hours
- Fill nail holes and gaps up to 1/2"
- Requires Qwik-Mixer for easy mixing and dispensing



## MANUAL 50 ML DISPENSE GUN

Made of highly engineered plastic to be lightweight and powerful. Easy loading breech provides secure cartridge fit.  
AAD50MLMG



## MANUAL 220 ML DISPENSE GUN

Its 26:1 mechanical advantage dispenses high- and low-viscosity adhesives with less user fatigue. Designed to maximize durability.  
AAD220MLHF



## QWIK-MIXERS (24/PK)

Required dispenser for Fast Cure and Slow Cure AZEK adhesive products. The resin and catalyst blend together as they travel down the tube to the applicator tip. Ensures 1:1 ratio mix and provides easy adhesive application. 24 per pack.

50 ml: AAD50MLSQM

220 ml: AAD220MLQM



## PVC TRIM NAIL ERASERS

Fills finish nail holes in PVC trim. White color perfectly matches AZEK trim. Resists yellowing.  
.5 oz: AADNEBLIS



## PLASTIC JOINING BISCUIT (50/PK)

PVC-compatible biscuits. Easy way to join, seal, and finish PVC Trim.  
BISCUIT PACK OF 50: AADPJB

## Industry-Leading Warranties

With decades in the business and dedicated investments to research and development, AZEK makes it our mission to provide the best materials on the market. We stand behind the integrity of our siding, cladding, trim, and moulding with a Lifetime Limited Warranty that covers corrosion, rotting, splintering, delamination, or swelling excessively from moisture. All AZEK products are also easy to maintain and resistant to mold, mildew, and moisture damage. For more information, visit [AZEKexteriors.com/warranty](http://AZEKexteriors.com/warranty).

## Contractor and Builder Information

AZEK Trim, Siding, and Moulding and TimberTech Cladding should be installed using the same good building principles used to install wood trim and mouldings and in accordance with the local building codes and established installation guidelines. AZEK accepts no liability or responsibility for the improper installation of AZEK products.

AZEK Siding, Trim, and Moulding may not be suitable for every application and it is the sole responsibility of the installer to be sure that AZEK Siding, Trim, and Moulding, and TimberTech Cladding are fit for the intended use. Since all installations are unique, it is also the installer's responsibility to determine specific requirements in regard to each application. AZEK recommends that all applications be reviewed by a licensed architect, engineer, or local building official before installation.

Technical information and AZEK Trim, Siding, and Moulding installation guides are available at [AZEKexteriors.com/resources](http://AZEKexteriors.com/resources) or from a local AZEK dealer. For further assistance, please call AZEK Customer Service at 1.800.910.3545 or visit our website at [AZEKexteriors.com](http://AZEKexteriors.com).

# ACCESSORIES

# ONLINE RESOURCES

Check out these tools and tips for everything AZEK Exteriors. They're online and available 24/7.



## NEW AZEK® VISUALIZER

Mock up trim, siding, and color options virtually, share images with others, or even create professional proposals.



DESIGN AND SHARE  
ONLINE

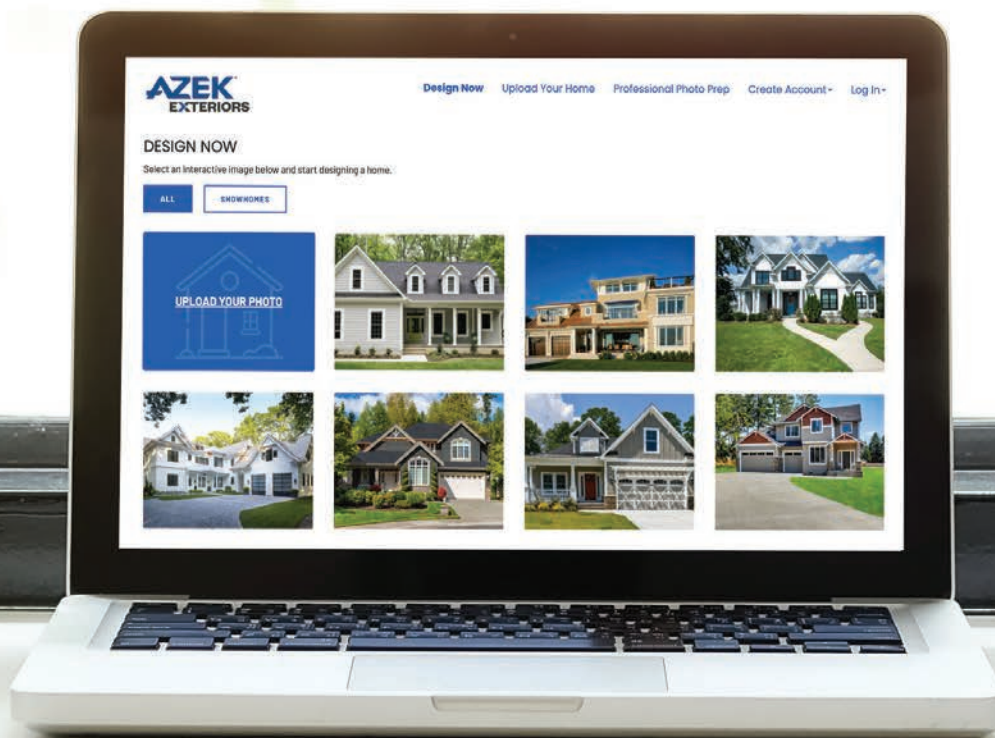

AZEKexteriors.com

© 2023 The AZEK Company Inc. and Its Affiliates

LIT-EXTERIORS REV 10/23



MADE IN  
THE USA